

PTG-149 GRILLE (POSITION #2)

STANDARD CONSTRUCTION FRAME

6063-T6 Extruded Aluminum
 .062" Nominal Wall Thickness

BLADES

6063-T6 Extruded Aluminum
 .062" Nominal Wall Thickness
 0.775" Blade Spacing

BRACE BARS

As Required NTE 16" OC

STANDARD FEATURES

- Aluminum Construction Providing High Resistance to Corrosion
- High Free Area and Low Resistance to Air Flow Air Flow Make This Ideal For PTAC Applications

OPTIONS

- Kynar Finish
- Various Frames/Adaptor Options
- Insulated & Non-Insulated Blank-Off Panels
- Blank-Off Cutouts For PTAC Unit
- Bird & Insect Screens

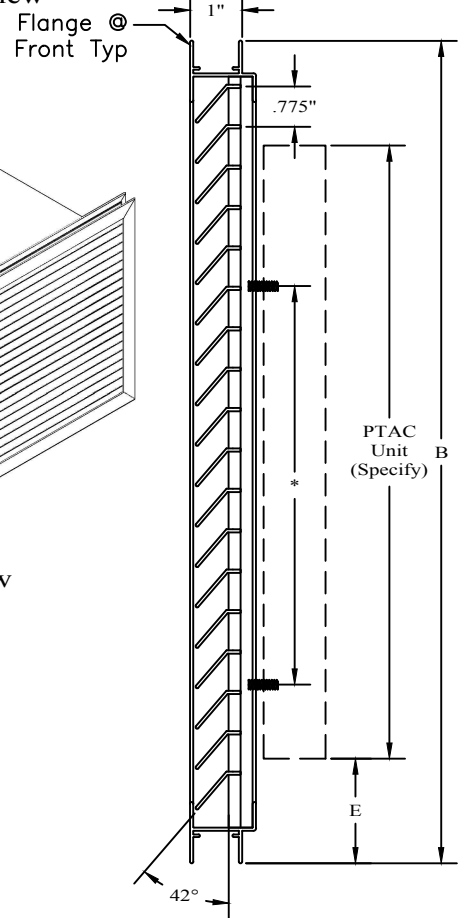
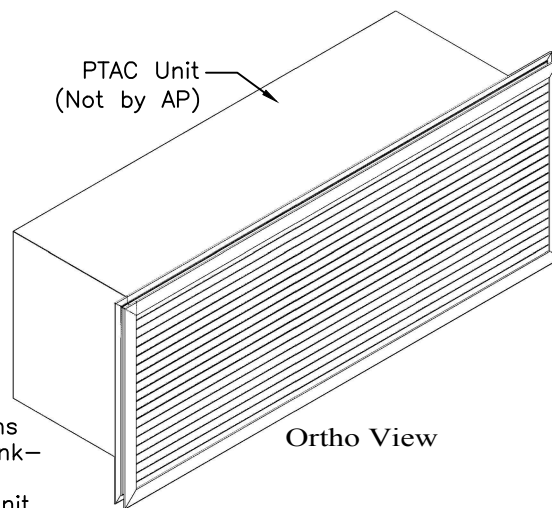
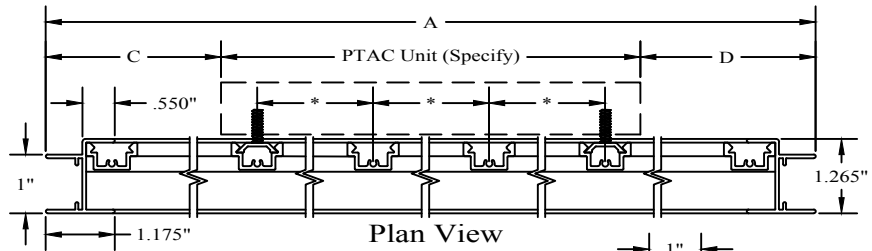

* Dimensions Determined by Unit, Model And Type

Unit Type	Unit Model No.	Specify Size					Variations
		A	B	C	D	E	